

Technical data sheet

Reduction, metric thread

Item number: 2030670

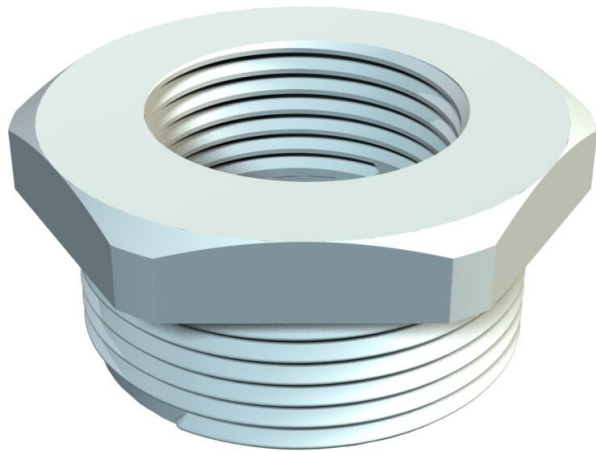

Reduction, with metric internal and external thread.



PA Polyamide

Master data

Item number	2030670
Type	107 R M63-32 PA
Description 1	Reduction
Manufacturer	OBO
Dimension	M63-M32
Colour	Light grey; RAL 7035
Material	Polyamide
Smallest sales unit	25
Unit of quantity	Units
Weight	3,07 kg
Weight unit	kg/100 pairs

Technical data sheet

Reduction, metric thread

Item number: 2030670



Dimensions

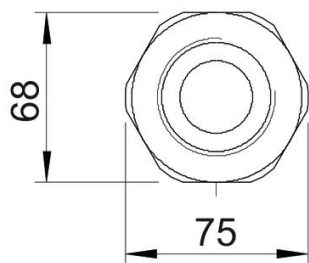
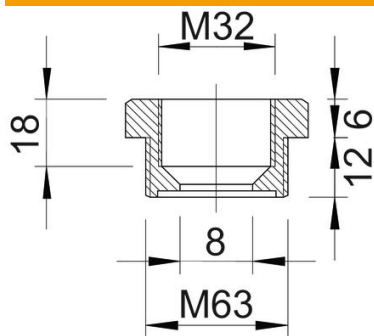

Dimension E	75 mm
Dimension L	18 mm
Dimension L1	12 mm
Dimension L2	6 mm
Dimension L3	18 mm

Technical specifications

explosion-proof	no
Thread type: External thread	Metric
Thread type: Internal thread	Metric
Thread length	12 mm
Thread dimension, metric, external	63
Thread dimension, metric, internal	32
Halogen-free	yes
WAF	68
Nickel-plated	no