

Technical data sheet

Reduction, metric thread

Item number: 2030634



Reduction, with metric internal and external thread.



PA Polyamide

Master data

Item number	2030634
Type	107 R M32-16 PA
Description 1	Reduction
Manufacturer	OBO
Dimension	M32-M16
Colour	Light grey; RAL 7035
Material	Polyamide
Smallest sales unit	50
Unit of quantity	Units
Weight	1,1 kg
Weight unit	kg/100 pairs

Technical data sheet

Reduction, metric thread

Item number: 2030634



Dimensions

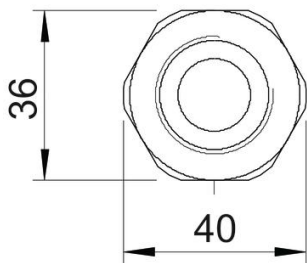
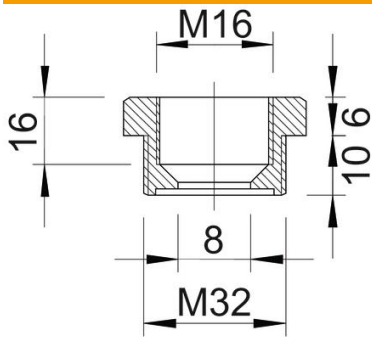

Dimension E	40 mm
Dimension L	16 mm
Dimension L1	10 mm
Dimension L2	6 mm
Dimension L3	16 mm

Technical specifications

explosion-proof	no
Thread type: External thread	Metric
Thread type: Internal thread	Metric
Thread length	10 mm
Thread dimension, metric, external	32
Thread dimension, metric, internal	16
Halogen-free	yes
WAF	36
Nickel-plated	no